

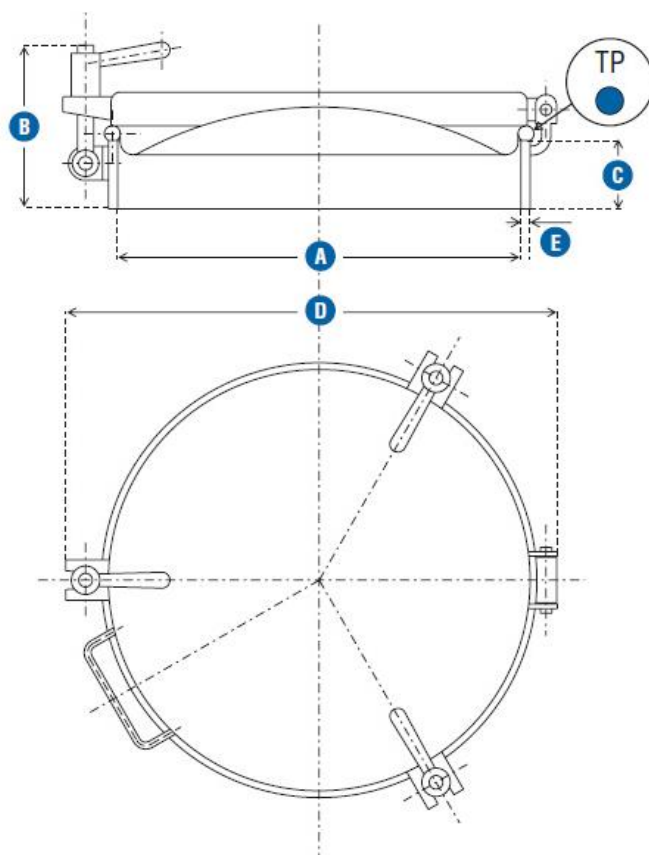





## Round External Doors - Design & Approval CODAP2000

### P22-238

Pressure Round External Manlids  
P22-238/239/249  
Retention Free Cover



Code	A	B	C	D	E		BAR 150°C			) BAR (		
							CODAP	ASME	TÜV			
P22-238	204	155	60	292	8	3	3.8	3.8	3.7	0.1		6
P22-239	354	155	60	441	8	3	2.2	2.2	1.3	0.1		11
P22-249	354	155	60	420	8	4	2.7	2.7	1.7	0.1		12

This Data Sheet refers to the material as supplied. The information contained herein is given in good faith, but no liability will be accepted by the Company in relation to same. We reserve the right to change the details given on this Data Sheet as additional information is acquired. Customers requiring the latest version of this Data Sheet should contact our sales department.

Unit N2, Gildersome Spur, Gildersome, Leeds, LS27 7JZ | Tel: 0113 252 6712 | Email: [info@manways.co.uk](mailto:info@manways.co.uk) | [www.manways.co.uk](http://www.manways.co.uk)