

Round External Doors - Single Arm, Hinged

D08-460

Upper Lid 'Aseptic' in AISI 304 or AISI 316 Stainless Steel access diameter. Max working pressure: 0.2 Bar (200/300/420)

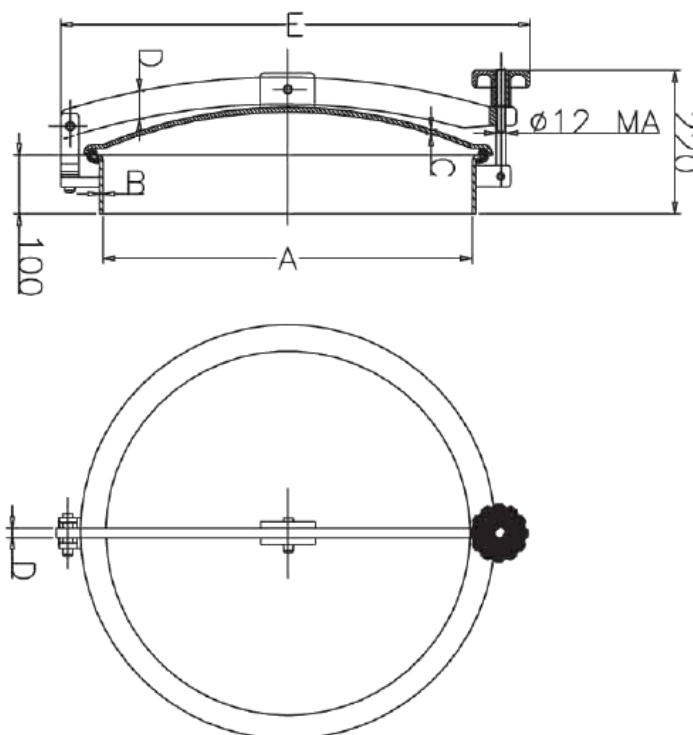

Diameter (A)	B	C	D	E
200	2.5	2	30x8	320
300	2.5	2	35x8	425
420	2.5	2.5	40x10	560
460	2.5	2.5	40x10	605
500	2.5	2.5	40x10	640
600	2.5	2.5	40x10	740

This Data Sheet refers to the material as supplied. The information contained herein is given in good faith, but no liability will be accepted by the Company in relation to same. We reserve the right to change the details given on this Data Sheet as additional information is acquired. Customers requiring the latest version of this Data Sheet should contact our sales department.

Unit N2, Gildersome Spur, Gildersome, Leeds, LS27 7JZ | Tel: 0113 252 6712 | Email: info@manways.co.uk | www.manways.co.uk